

TWILIGHT SERIES



- DARK SKY COMPLIANT
- SEALED OPTICS CHAMBER
- FULL CUT OFF OPTIONS
- TOOL FREE ACCESS
- BIRD RESISTANT
- IP 65 RATED
- UL LISTED
- AAMA 2604-05 HIGH PERFORMANCE COATINGS



OUTDOOR LIGHTING SPECIALISTS SINCE 1972

320 Clark Dr. | El Paso, TX 79951

Phone: (915) 779-1405

Toll Free: (800) 648-9013

Fax: (915) 779-3618

Toll Free: (888) 779-3065

email: info@nilandco.com

www.nilandco.com

Twilight Series

Twilight Series

Demonstrating a new perspective on antique style designs. Manufactured to carry out high performance with twist and seal optics while honoring our master craftsman of the past. The outcome is a luminaire that delivers high performance photometric distribution with full cutoff efficiency.

Features:

- ~ Construction from **all cast** materials, the Twilight Series maintains superb performance in the toughest surroundings.
- ~ **Twist 'N' Seal** optical system seemingly eliminates luminaire contaminants from degrading output of the sealed optical chamber.
- ~ **Tool-Free Access** to reflector for quick and easy relamping.
- ~ **No vertical glass surfaces.**
- ~ Optical chamber offers **unbeatable performance** and full cut off with a combination of a hydro-formed aluminum reflector and tempered glass lens.
- ~ Optional canopies available to **customize** any one of your projects.



featured luminaires



MODEL#:	BA-CON-HYD-HOR	BA-CON-J-HYD-HOR	BA-CON-T-HYD-HOR	BA-PEN-HYD-HOR
WIDEST DIA:	19.125 INCHES	19.125 INCHES	19.125 INCHES	19.125 INCHES
HEIGHT:	33.5 INCHES	37.25 INCHES	33.25 INCHES	37.5 INCHES

additional luminaires

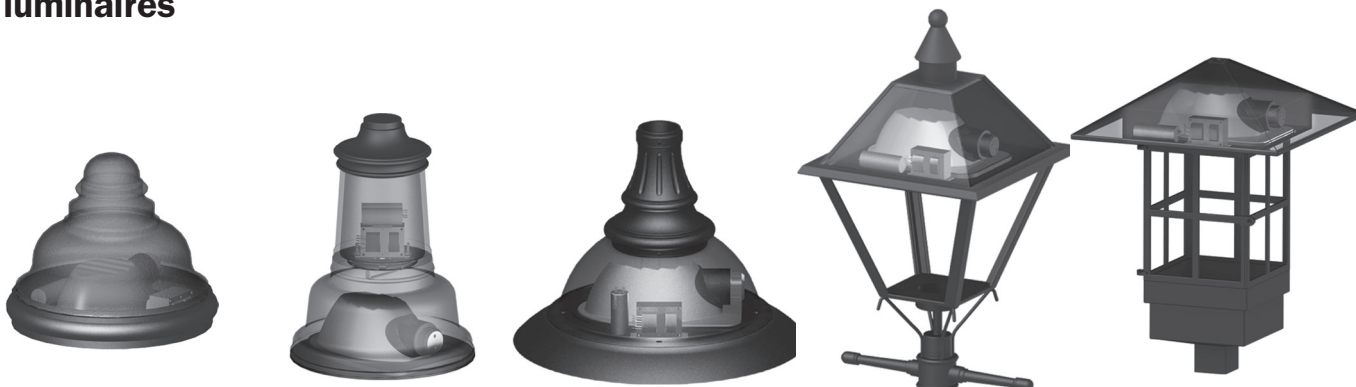

MODEL#:	SZ-FLAT	BC-17-FLAT	RS-BC-26-FLAT	JT-HYD-HOR	AP-HYD-HOR
WIDEST DIA:	20 INCHES	17 INCHES	25.875 INCHES	23 INCHES	24 INCHES
HEIGHT:	16.25 INCHES	19.375 INCHES	19.75 INCHES	41.25 INCHES	36 INCHES



Internal Component Access

Luminaires hoods open with lift and twist motion on the butterfly lock located on the hood rim. The hood then pivots on a hinge incorporated in the technical ring. An extended length chain link securely holds the lid at a comfortable angle for clear access to internal components.

ballast/lamp

Model	Description
70HPS	70 watt high pressure sodium; use a medium base, clear ED-17 lamp.
100HPS	100 watt high pressure sodium; use a medium base, clear ED-17 lamp.
150HPS	150 watt high pressure sodium; use a medium base, clear ED-17 lamp.
50MH	50 watt metal halide; use a medium base, clear ED-17 lamp.
70MH	70 watt metal halide; use medium base, clear ED-17 lamp.
70MHT6	70 watt metal halide; use a G12 base, T-6 ceramic MH lamp.
100MH	100 watt metal halide; use medium base, clear ED-17 lamp.
150MH	150 watt metal halide; use medium base, clear ED-17 lamp.
150MHT6	150 watt metal halide; use G12 base, T-6 ceramic MH lamp.
175MH	175 watt metal halide; use medium base, clear ED-17 lamp.
CF	Compact Fluorescent, electronic ballast; Use 4-pin 26,32 or 42 watt lamp.

voltage

120 / 208 / 240
/ 277 / 347* / 480*

*Not available for QL lamp.

Multitap ballast also available.

**Please specify wattage and voltage upon ordering.

Lamps (bulbs) not included in packages.

Induction Lighting Systems 100,000 HOURS AVERAGE LIFE

**Multiple Wattage Systems
Offering Electrodeless Technology with
up to 100,000 Hours Rated Average Life!**

Features:

- Ultra Long Life
- Crisp White Light
- No Color Shift
- High Reliability
- Operates in Hot & Cold Environments
- Low EMI
- High Lumen Output

With Induction Lighting,
the grass IS greener!



High Power LED Units OVER 200,000 HOURS AVERAGE LIFE

**Retrofits for Existing Fixtures
or As A Complete Unit**

Features:

- Increased Visual Acuity
- Minimal Energy Consumption
- Dark Sky Friendly
- Decreased Maintenance
- Instant "On"
- Wireless Access and Dimming Capabilities
- 40ft Maximum Mounting Height
- Lighting Detection System

Without the use of harmful mercury that traditional HID lamps use, the grass is not only greener, **it's growing!**



Lamp Access

Quick disconnect terminals between the lamp and ballast allow for safe removal of the lamp. Tool-free quarter-turn of the Twist'N'Seal base makes for easy relamping with a sealed optics chamber.



Remote Ballast

Ballast is easily accessed by removing the bird plate and the unitized ballast tray. Quick disconnect terminals are again used to ensure safe ballast maintenance.

photometric data - BA-CON-HYD-HOR 150HPS

The values below are initial footcandles. Decrease values to justify light losses due to voltage, temperature and atmospheric variations which may affect light output. All testing performed by a certified independant laboratory. Photometry is available in IES formatted files on CD-ROM and website at www.nilandco.com or call your local representative.



FLUX DISTRIBUTION

	Lumens	Percent Of Lamp
Downward Street Side	5729.6	35.8
Downward House Side	4806.0	30.0
Downward Total	10535.6	65.8
Upward Street Side	7.7	0.0
Upward House Side	10.5	0.1
Upward Total	18.2	0.1
Total Flux	10553.8	66.0

COEFFICIENTS OF UTILIZATION

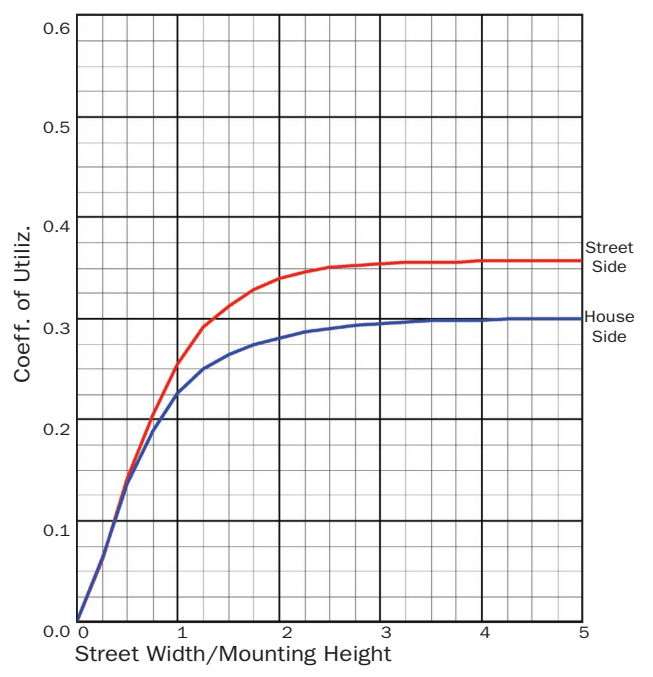

POLAR GRAPH

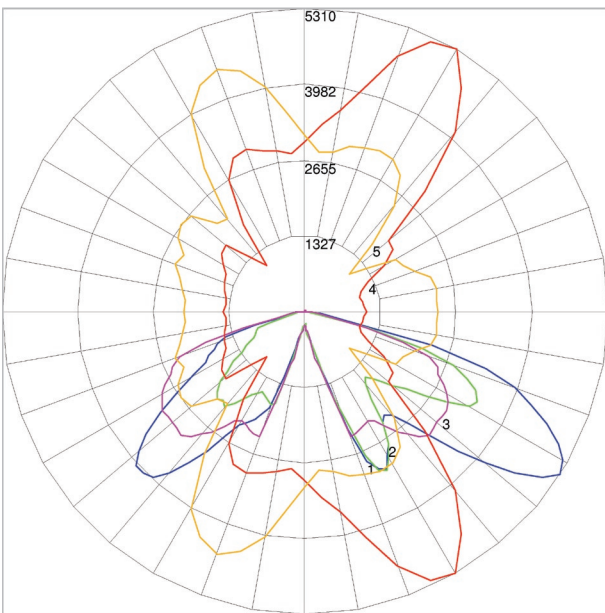

- Maximum Candela = 5309.91
- LOcated at Horizontal Angle = 60, Vertical Angle = 57.5
- #1 - Vertical Plane Through Horizontal Angles (60-240) (Through Max. Cd.)
- #2 - Vertical Plane Through Horizontal Angles (45-225)
- #3 - Vertical Plane Through Horizontal Angles (90-270)
- #4 - Horizontal Cone Through Vertical Angle (57.5) (Through Max. Cd.)
- #5 - Horizontal Cone Through Vertical Angle (45)

ISO FOOTCANDLE LINES OF HORIZONTAL ILLUMINANCE

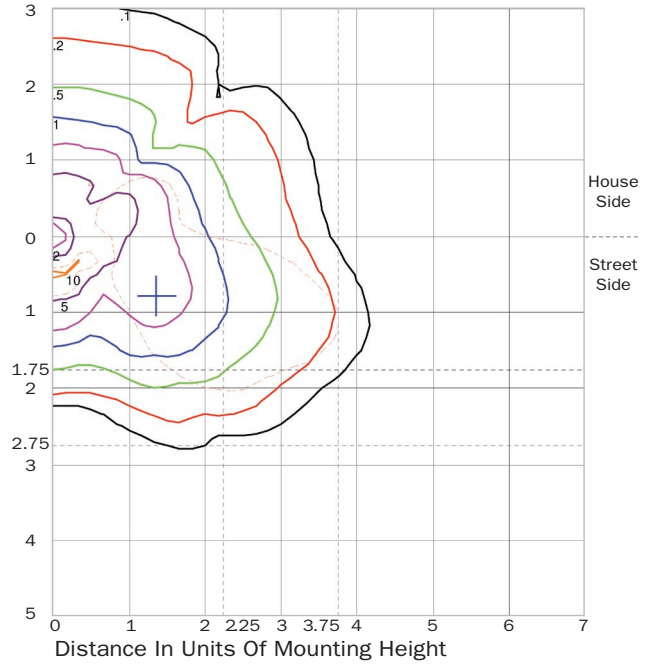

Values Based On 15 Foot Mounting Height
 1/2 Maximum Candela Trace Shown As Dashed Curve
 (+) = Maximum Candela Point
 Photometric data containing additional wattages and luminares are available online at <http://www.nilandco.com>.

optional arms



Cripple Creek - Single
CCR-2 HEIGHT: 24" LENGTH: 24"



Cripple Creek with Scroll - Double
CCR-SC-2 HEIGHT: 54" LENGTH: 65"

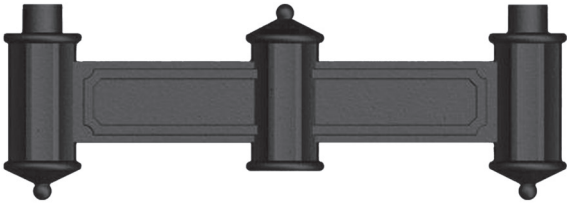

Denver - Double
DV-2 HEIGHT: 15" LENGTH: 43"

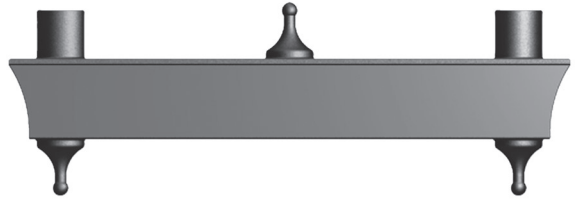

Security - Double
SEC-2 HEIGHT: 11.5" LENGTH: 30.5"



Mission - Single
MI-1 HEIGHT: 12" LENGTH: 45"



Mission - Double
MI-2 HEIGHT: 12" LENGTH: 94"

configurations:

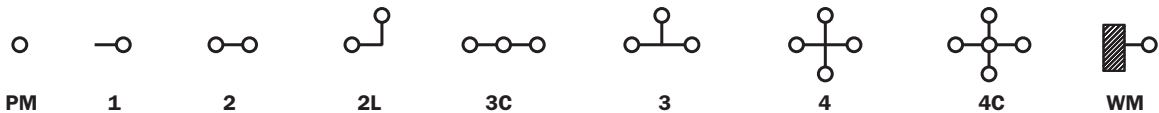

decorative poles and bases



MODEL#:	CL-17	NS-12	N-17	LD-10	NP-10.5
BASE HEIGHT:	27.75 INCHES	37.25 INCHES	21 INCHES	42.5 INCHES	28 INCHES
BASE DIA:	17 INCHES	12 INCHES	17 INCHES	10 INCHES	10.5 INCHES
SHAFT DIA:	5 INCHES	5 INCHES	5 INCHES	4 INCHES	4 INCHES

Pole Heights Variable Up to 16 Feet.

Shaft Options

FLUTED SMOOTH TAPERED

All shafts are with 4 or 5 inch diameter.
Tapered shafts offered as 7 inches at base to 4 inches at top only.

uncompromised

All bases are Cast Aluminum with minimum wall thickness of .250 inches. Base casting has an internal sleeve of up to 25 inches deep. Shaft will be seated into the base sleeve and circumferentially welded around the inside of the base for uncompromised structural integrity. All exterior welds ground smooth.

finish options



Textured
Forest Green (TG)

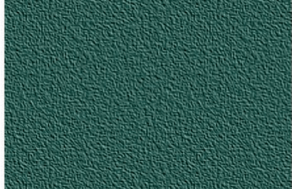

Textured
Playground Green (TP)



Textured
El Paso Green (TE)



Gloss
Green (GG)



Gloss
Black Green (BG)



Textured
Black (TB)



Mineral
Bronze (MR)



Hand Brushed
Verdi Gris (VG)



Gloss
Black (GB)



Gloss
Walnut (GW)

All finishes above are standard and offered at no extra charge.
Custom colors: please provide RAL number or sample chip.

accessories

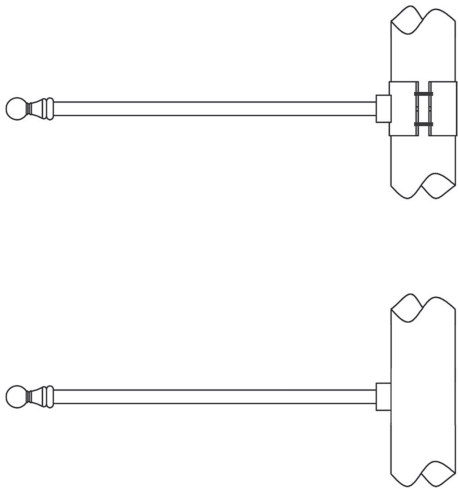

Banner Arms (BAN)

All banner arms fabricated with 24-inch round aluminum shaft at 1-inch diameter. Clamped, welded, or bolted to 4 or 5 inch diameter pole. Double banner arms also available.

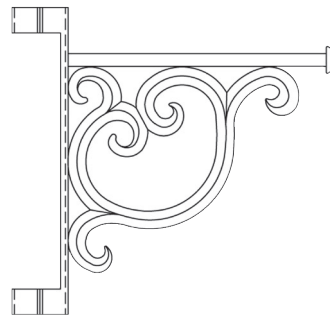

Planter Arms (PA)

All planter arms fabricated with aluminum at 28 inch height and 24 inch length. Clamped around diameter of 4 inch or 5 inch pole. Double planter arms also available.

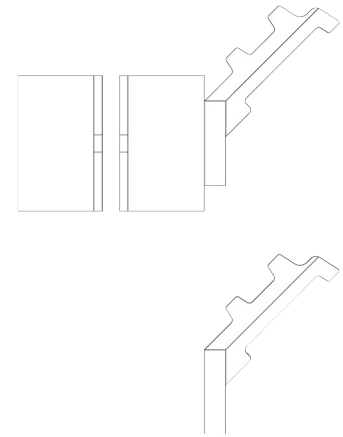

Flag Pole Holder (FLAG)

Holders are available as clamp or bolt mount for 4 inch or 5 inch poles. Overall height is 4 inches and reach is 3 inches.

sign backers

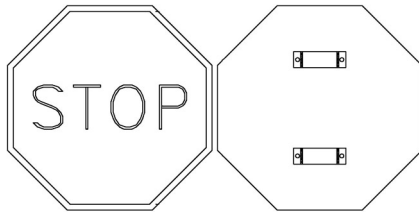

POLE MOUNT: FRONT BACK

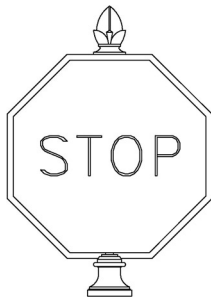

TOP MOUNT: FRONT

Stop Sign Backer (STOP)

Stop Signs available in 24 inch or 30 inch diameter. Fabricated in 356 cast aluminum with a thickness of .1875 inch and .375 inch offset lip. Can be clamped around 4 inch or 5 inch diameter pole. Bolt and top mount also available. Please specify mounting height upon ordering.

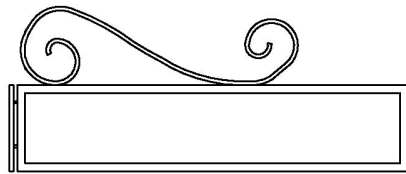

PAD-24-SQ-SC

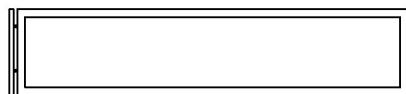

PAD-24-SQ

24 Inch Square Paddle Sign Backer (PAD-24-SQ)

Square Street Sign Paddles available in 24 inch length by 4.5 inch height. Fabricated in 356 cast aluminum with a thickness of .1875 inch and .375 inch offset lip. Can be clamped around 4 inch or 5 inch diameter pole. Bolt mount also available. Please specify mounting height upon ordering. Optional decorative scroll available.

All signage does NOT include dacals. Please specify heighth and width when ordering custom sizes.

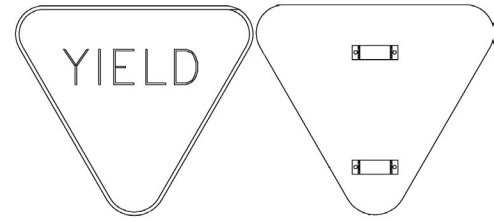

POLE MOUNT: FRONT BACK

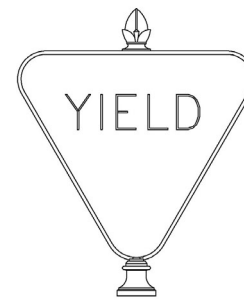

TOP MOUNT: FRONT

Yield Sign Backer (YIELD)

Yield Signs available in 28 inch or 30 inch height. Fabricated in 356 cast aluminum with a thickness of .1875 inch and .375 inch offset lip. Can be clamped around 4 inch or 5 inch diameter pole. Bolt and top mount also available. Please specify mounting height upon ordering.

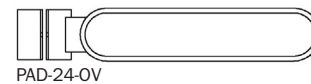

PAD-24-OV

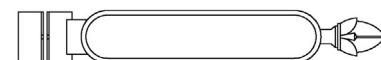

PAD-24-OV-FINIAL

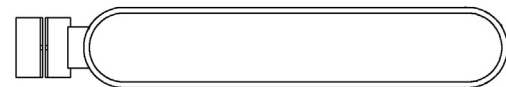

PAD-36-OV

24 Inch Oval Paddle Sign Backer (PAD-24-OV or PAD-36-OV)

Oval Street Sign Paddles available in 24 inch length by 4.5 inch height or 36 inch length by 6 inch height. Fabricated in 356 cast aluminum with a thickness of .1875 inch and .375 inch offset lip. Can be clamped around 4 inch or 5 inch diameter pole. Bolt mount also available. Please specify mounting height upon ordering. Optional decorative finial available.

Twilight Series

scaled view



BASE/POLE:	NP-10-F4-10	CL-17-F5-13	NS5-12-F5-16	N-17-F5-12	LD-10-F4-10
ARM:	-	DV-2	CCR-SC-1	SEC-2	SEC-2
LUMINIARE:	BA-CON-J-HYD-HOR	BA-CON-HYD-HOR	BA-PEN-HYD-HOR	BA-CON-J-HYD-HOR	BA-CON-T-HYD-HOR

ordering guide

Example: N-17 - F5 - 14 - DV - 2 - BA-CON-HYD-HOR - MH - 240 - 100 - TB - BAN-1
 (A) (B) (C) (D) (E) (F) (G) (H) (I) (J) (K)

(A)BASE TYPE:

- CL-17 = Cleveland Series with 17" dia.
- NS-12 = Maintstreet Series with 12" dia.
- N-17 = Niland Series with 17" dia.
- LD-10 = Londonderry Series with 10" dia.
- NP-10.5 = Naples Series with 10.5" dia.

(B)POLE/SHAFT TYPE:

- F4 = Fluted 4" dia.
- F5 = Fluted 5" dia.
- S4 = Smooth 4" dia.
- S5 = Smooth 5" dia.

(C)HEIGHT:

- 8 = 8Ft
- 9 = 9Ft
- 10 = 10Ft
- 11 = 11Ft
- 12 = 12Ft
- UP TO 16Ft

(D)ARM TYPE:

- MI = Mission
- DV = Denver
- SEC = Security
- CCR = Cripple Creek
- CCR-SC = Cripple Creek with Scroll

(E)NUMBER OF ARMS:

UP TO 4 ARMS

(F)FIXTURE TYPE:

(all luminaires come stock with type III hydro-formed reflector)

- SZ-FLAT = Santa Cruz Flat
- BC-17-FLAT = Boston Common 17" Flat
- RS-BC-26-FLAT = Residency 26" Flat
- BA-PEN-HYD-HOR = Barcelona Pendent Mount
- BA-CON-HYD-HOR = Barcelona Standard Finial
- BA-CON-T-HYD-HOR = Barcelona T Type Finial
- BA-CON-J-HYD-HOR = Barcelona J Type Finial
- JT-HYD-HOR = Jamestown Cut Off
- AP-HYD-HOR = Aspen Cut Off

(G)LAMP TYPE:

- MH = Metal Halide
- HPS = High Pressure Sodium
- CF = Compact Fluorescent
- QL = QL Induction Lamp

(H)VOLTAGE:

- 120 = 120 Volts
- 208 = 200 Volts
- 240 = 240 Volts
- 277 = 277 Volts
- 347* = 347 Volts*
- 480* = 480 Volts*
- MT = Multitap (120,208,240,277)

*Not available for QL lamp.

(I)WATTAGE:

Pease reference ballast chart on page 4.

(J)FINISH:

- TB = Textured Black
- TE = Textured El Paso Green
- TG = Textured Forest Green
- TP = Textured Playground Green
- MR = Mineral Bronze
- GB = Gloss Black
- GG = Gloss Green
- BG = Black Green
- GW = Gloss Walnut
- VG = Handbrushed Verdi Gris
- CUSTOM = Specify RAL # or Provide Sample

(K)ACCESSORES:

- BAN-1 = Single Banner Arm
- BAN-2 = Double Banner Arm
- PA-1 = Single Planter Arm
- PA-2 = Double Planter Arm
- FLAG = Flag Pole Holder
- STOP-TM = Top Mount Stop Sign Backer
- STOP-PM = Pole Mount Stop Sign Backer
- YIELD-TM = Top Mount Yield Sign Backer
- YIELD-PM = Pole Mount Yield Sign Backer
- PAD-24-SQ = 24" Square Paddle Sign Backer
- PAD-24-SQ-SC = 24" Square Paddle Sign Backer with Scroll
- PAD-24-OV = 24" Oval Paddle Sign Backer
- PAD-24-OV-FINIAL = 24" Oval Paddle Sign Backer with Standard Finial
- PAD-36-OV = 36" Oval Paddle Sign Backer



TWILIGHT SERIES



Cutoff



Full Cutoff



Cutoff



Full Cutoff



Cutoff



Full Cutoff



Cutoff



Cutoff



Cutoff



320 Clark Dr. | El Paso, TX 79951

Phone: (915) 779-1405

Toll Free: (800)648-9013

Fax: (915)779-3618

Toll Free: (888)779-3065

email: info@nilandco.com

www.nilandco.com