



■ Features :

- Universal AC input / Full range (up to 305VAC)
- Protections: Short circuit / Overload / Over voltage / Over temperature
- Built-in active PFC function
- Cooling by free air convection
- OCP point adjustable through output cable or internal potential meter
- Suitable for LED lighting and moving sign applications
- IP67 / IP65 design for indoor or outdoor installations
- Compliance to worldwide safety regulations for lighting
- 3 years warranty



HLG-240H-12 [A] Blank : IP67 rated. Cable for I/O connection. (Optional)
 A : IP65 rated. Output voltage and constant current level can be adjusted through internal potential meter.
 B : IP67 rated. Constant current level adjustable through output cable. (Optional)
 C : Terminal block for I/O connection. Output voltage and constant current level can be adjusted through internal potential meter. (Optional)

SPECIFICATION

MODEL	HLG-240H-12	HLG-240H-15	HLG-240H-20	HLG-240H-24	HLG-240H-30	HLG-240H-36	HLG-240H-42	HLG-240H-48	HLG-240H-54		
OUTPUT	DC VOLTAGE	12V	15V	20V	24V	30V	36V	42V	48V	54V	
	CONSTANT CURRENT REGION Note.4	6 ~ 12V	7.5 ~ 15V	10 ~ 20V	12 ~ 24V	15 ~ 30V	18 ~ 36V	21 ~ 42V	24 ~ 48V	27 ~ 54V	
	RATED CURRENT	16A	15A	12A	10A	8A	6.7A	5.72A	5A	4.45A	
	RATED POWER	192W	225W	240W	240W	240W	241.2W	240.2W	240W	240.3W	
	RIPPLE & NOISE (max.) Note.2	150mVp-p	150mVp-p	150mVp-p	150mVp-p	200mVp-p	250mVp-p	250mVp-p	250mVp-p	350mVp-p	
	VOLTAGE ADJ. RANGE Note.6	11.2 ~ 12.8V	14 ~ 16V	18.6 ~ 21.4V	22.4 ~ 25.6V	28 ~ 32V	33.5 ~ 38.5V	39 ~ 45V	44.8 ~ 51.2V	50 ~ 57V	
	CURRENT ADJ. RANGE	Can be adjusted by internal potential meter or through output cable									
		8 ~ 16A	7.5 ~ 15A	6 ~ 12A	5 ~ 10A	4 ~ 8A	3.3 ~ 6.7A	2.86 ~ 5.72A	2.5 ~ 5A	2.23 ~ 4.45A	
	VOLTAGE TOLERANCE Note.3	±2.5%	±2.0%	±1.0%	±1.0%	±1.0%	±1.0%	±1.0%	±1.0%	±1.0%	
	LINE REGULATION	±0.5%	±0.5%	±0.5%	±0.5%	±0.5%	±0.5%	±0.5%	±0.5%	±0.5%	
LOAD REGULATION	±2.0%	±1.5%	±1.0%	±0.5%	±0.5%	±0.5%	±0.5%	±0.5%	±0.5%		
SETUP, RISE TIME Note.9	2500ms, 80ms at full load 230VAC /115VAC										
HOLD UP TIME (Typ.)	15ms at full load 230VAC /115VAC										
INPUT	VOLTAGE RANGE Note.5	90 ~ 305VAC		127 ~ 431VDC							
	FREQUENCY RANGE	47 ~ 63Hz									
	POWER FACTOR	PF0.95/230VAC		PF ≥ 0.98/115VAC at full load and rated output voltage				PF ≥ 0.9 at 65 ~ 100% load			
	EFFICIENCY (Typ.)	90%	90%	92%	93%	93%	93%	93%	93.5%	94%	
	AC CURRENT	4A / 115VAC		2A / 230VAC							
	INRUSH CURRENT(Typ.)	COLD START 75A/230VAC									
	LEAKAGE CURRENT	<0.75mA / 277VAC									
PROTECTION	OVER CURRENT Note.4	95 ~ 108% Protection type : Constant current limiting, recovers automatically after fault condition is removed									
	SHORT CIRCUIT Note.7	Hiccup mode, recovers automatically after fault condition is removed.									
	OVER VOLTAGE	13.5 ~ 16V	16.5 ~ 19.5V	22 ~ 26V	26 ~ 33V	32.5 ~ 36.5V	40 ~ 48V	46 ~ 50V	53 ~ 62V	59 ~ 65V	
	OVER TEMPERATURE	105°C ±5°C (TSW1) Protection type : Shut down o/p voltage, recovers automatically after temperature goes down									
ENVIRONMENT	WORKING TEMP.	-30 ~ +60°C @ full load ; +70°C @ 60% load (Refer to derating curve)									
	WORKING HUMIDITY	20 ~ 95% RH non-condensing									
	STORAGE TEMP., HUMIDITY	-40 ~ +80°C, 10 ~ 95% RH									
	TEMP. COEFFICIENT	±0.03%/°C (0 ~ 50°C)									
	VIBRATION	10 ~ 500Hz, 5G 12min./1cycle, period for 72min. each along X, Y, Z axes									
SAFETY & EMC	SAFETY STANDARDS Note.8	UL1012 ; EN61347-1, EN61347-2-13 independent (except for HLG-240H C type) ; UL60950-1, TUV EN60950-1									
	WITHSTAND VOLTAGE	I/P-O/P:3.75KVAC		I/P-FG:1.88KVAC		O/P-FG:0.5KVAC					
	ISOLATION RESISTANCE	I/P-O/P, I/P-FG, O/P-FG:100M Ohms / 500VDC / 25°C / 70% RH									
	EMI CONDUCTION & RADIATION	Compliance to EN55015, EN55022 (CISPR22) Class B									
	HARMONIC CURRENT	Compliance to EN61000-3-2 Class C (≥ 50% load) ; EN61000-3-3									
OTHERS	EMM IMMUNITY	Compliance to EN61000-4-2,3,4,5,6,8,11; ENV50204, EN61547, EN55024, heavy industry level (surge 4KV), criteria A									
	MTBF	207.9Khrs min. MIL-HDBK-217F (25°C)									
	DIMENSION	244.2*68*38.8mm (L*W*H)(HLG-240-Blank/A/B)				251*68*38.8mm (L*W*H)(HLG-240-C)					
	PACKING										
	1.3Kg; 12pcs/16.6Kg/0.74CUFT(HLG-240-Blank/A/B)				1.23Kg; 12pcs/15.8Kg/1.16CUFT(HLG-240-C)						
NOTE	<ol style="list-style-type: none"> 1. All parameters NOT specially mentioned are measured at 230VAC input, rated load and 25°C of ambient temperature. 2. Ripple & noise are measured at 20MHz of bandwidth by using a 12" twisted pair-wire terminated with a 0.1uf & 47uf parallel capacitor. 3. Tolerance : includes set up tolerance, line regulation and load regulation. 4. Constant current operation region is within 50% ~ 100% rated output voltage. This is the suitable operation region for LED related applications, but please reconfirm special electrical requirements for some specific system design. 5. Derating may be needed under low input voltages. Please check the derating curve for more details. 6. Type A and type C only. 7. Please refer to OLP characteristics. 8. Safety and EMC design refer to EN60598-1, subject 8750(UL), CNS15233, GB7000.1, FCC part18. 9. Length of set up time is measured at cold first start. Turning ON/OFF the power supply may lead to increase of the set up time. 10. The power supply is considered as a component that will be operated in combination with final equipment. Since EMC performance will be affected by the complete installation, the final equipment manufacturers must re-qualify EMC Directive on the complete installation again. 										

Mechanical Specification

Case No.994C Unit:mm

Blank:(HLG-240H)

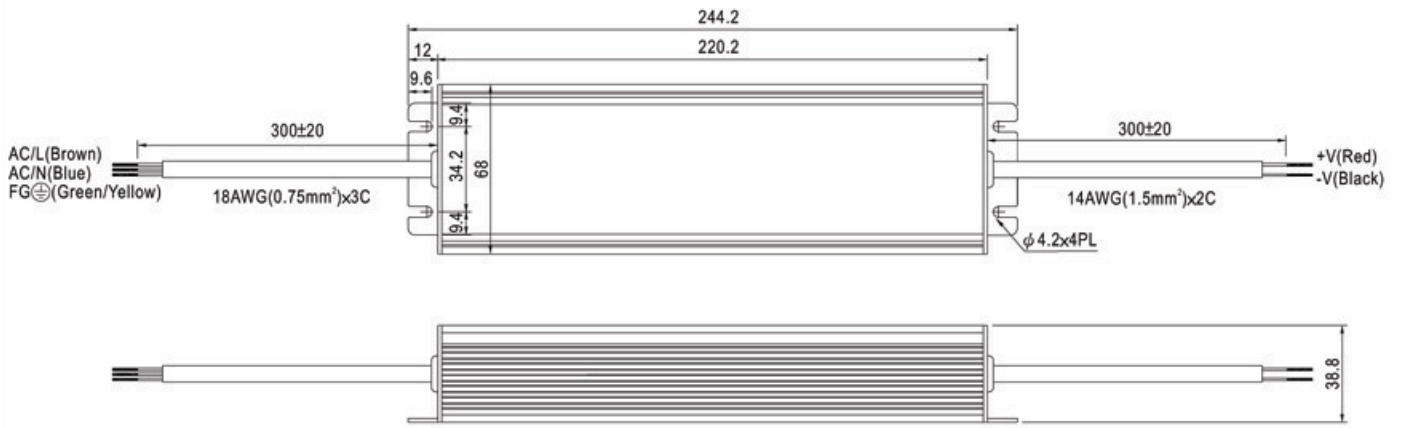

※IP67 rated. Cable for I/O connection.

A Type:(HLG-240H-A)

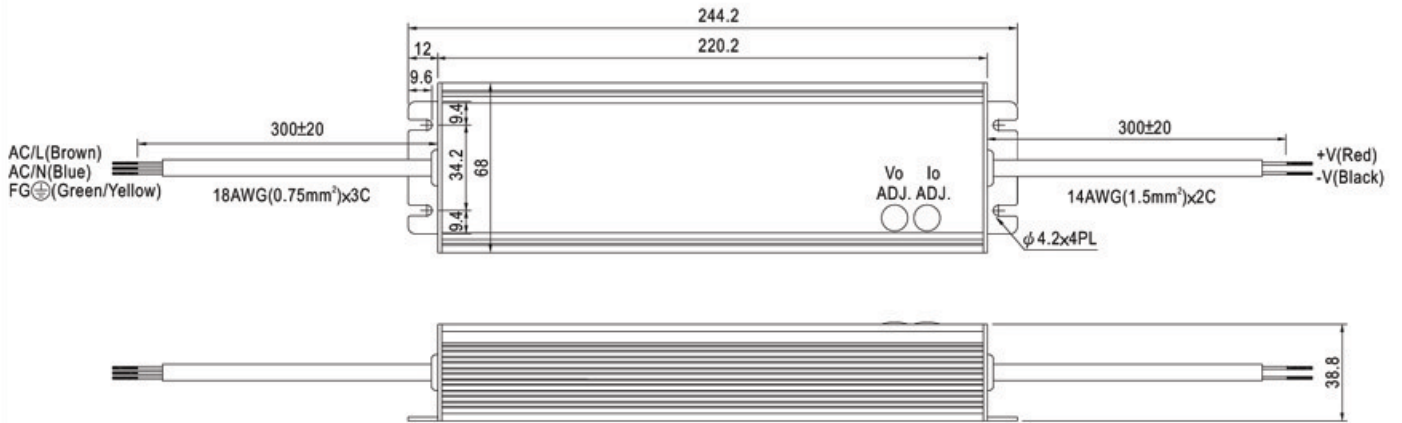

※ IP65 rated. Output voltage and constant current level can be adjusted through internal potential meter.
(Can access by removing the rubber stopper on the case.)

B Type:(HLG-240H-_B)

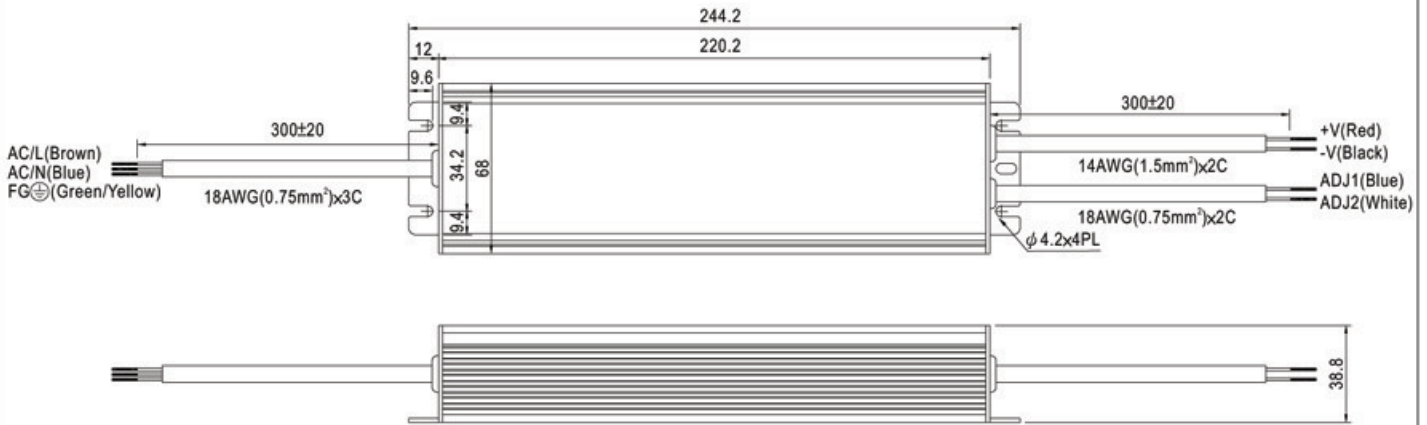

※ IP67 rated. Output constant current level can be adjusted through output cable by connecting a resistor between ADJ1 and ADJ2.

※ Reference resistance value for output current adjustment (Typical)

Percentage of rated current	Model	12V	15V	20V	24V	30V	36V	42V	48V	54V
Slightly > 100%		Open	Open	Open	Open	Open	Open	Open	Open	Open
75%		680Ω	560Ω	680Ω	510Ω	820Ω	560Ω	680Ω	620Ω	820Ω
50%		120Ω	47Ω	91Ω	51Ω	120Ω	33Ω	82Ω	68Ω	150Ω
Slightly < 50%		Short	Short	Short	Short	Short	Short	Short	Short	Short

C Type:(HLG-240H-_C)

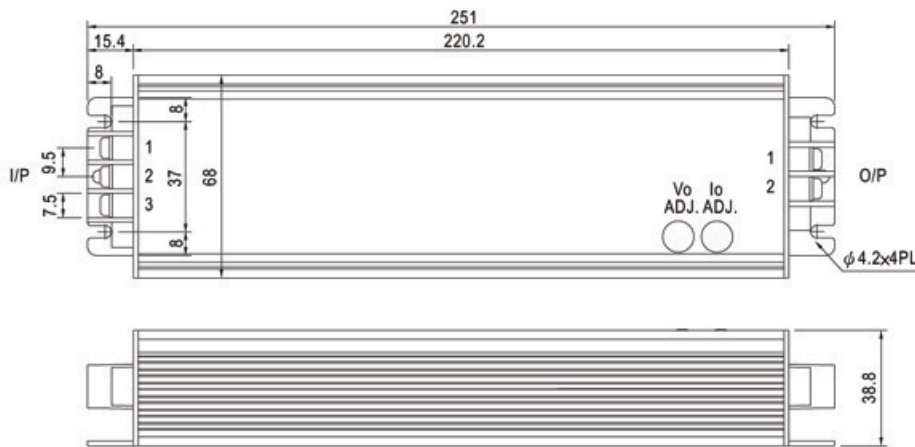

AC Input Terminal Pin No. Assignment

Pin No.	Assignment
1	FG \perp
2	AC/L
3	AC/N

DC Output Terminal Pin No. Assignment

Pin No.	Assignment
1	-V
2	+V

※ Output voltage and constant current level can be adjusted through internal potential meter.
(Can access by removing the rubber stopper on the case.)

Block Diagram

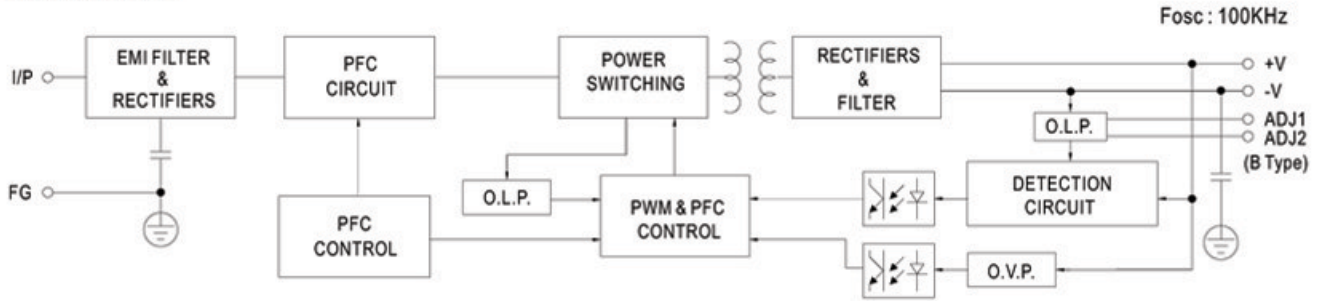

Derating Curve

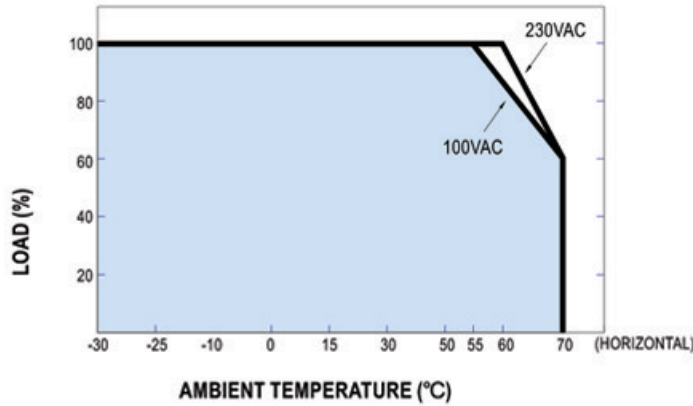

Static Characteristics

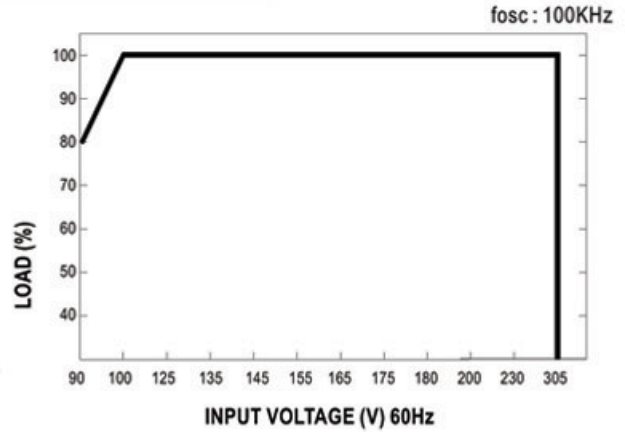

Power Factor Characteristic

Power factor will be higher than 0.9 when output loading is 65% or higher.

Constant Current Mode

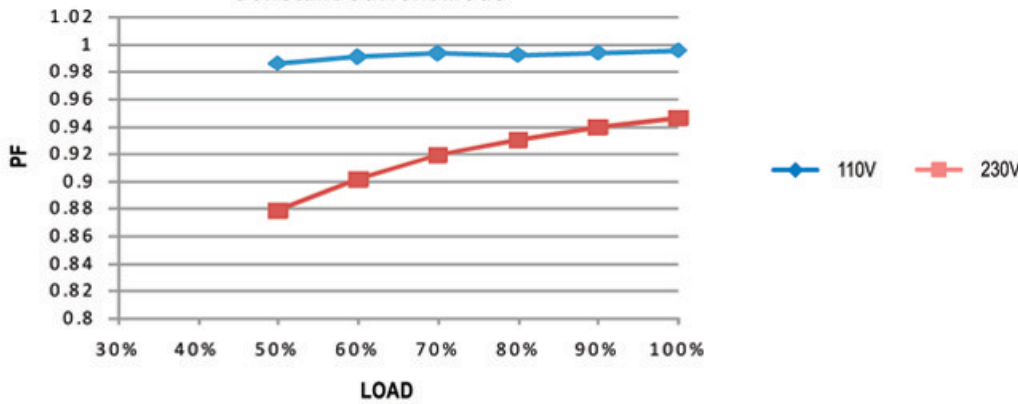

EFFICIENCY vs LOAD (48V Model)

H LG-240H series possess superior working efficiency that up to 93.5% can be reached in field applications.

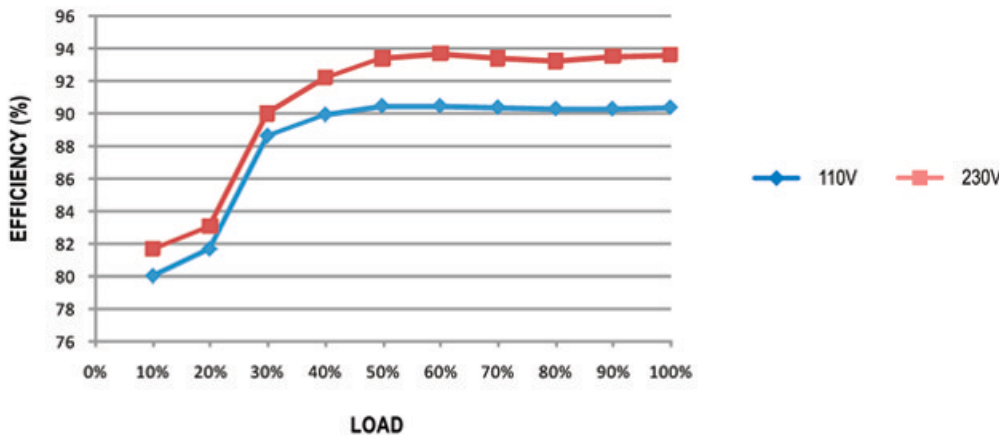

DRIVING METHODS OF LED MODULE

There are two major kinds of LED drive method "direct drive" and "with LED driver".

A typical LED power supply may either work in "constant voltage mode (CV) or constant current mode (CC)" to drive the LEDs.

Mean Well's LED power supply with CV+ CC characteristic can be operated at both CV mode (with LED driver, at area (A) and CC mode (direct drive, at area (B)).

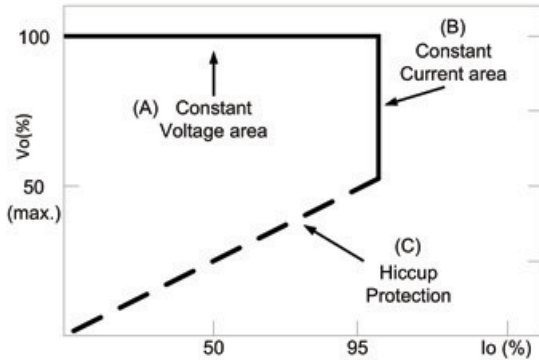

Typical LED power supply I-V curve

⊙ **Direct driving :**

Under direct driving, the power supply will work in "constant current mode (CC)" and output voltage of the power supply will be clamped by sum of forward voltage (V_f) of the LED strip.

The total forward voltage of series connecting LEDs is suggested for 75%~95% of power supply rated output voltage due to concern of the best PF value and efficiency.



⊙ **With LED driver :**

Using additional driver, the power supply will work in "constant voltage mode (CV)" and output voltage of the power supply will be kept in rated value. In this drive mode, several design issues need to be considered:

1. Output voltage of PSU must be higher than total forward voltage of series connecting LEDs by 3V minimum.
2. Input capacitor (C_{in}) of LED driver circuit should use 2.2uF ~ 22uF (typ.) of rating depends on the operating frequency of the LED driver.

The higher the operating frequency is used, the smaller value of C_{in} should be chosen, and vice versa.

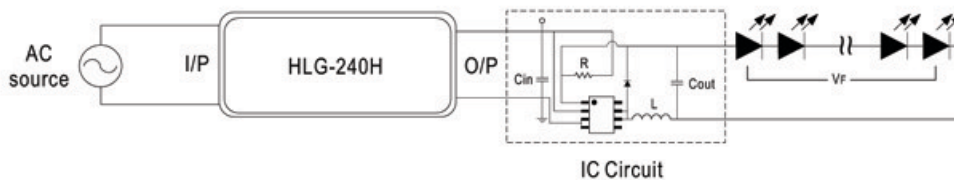

EMI DEBUG SUGGESTION

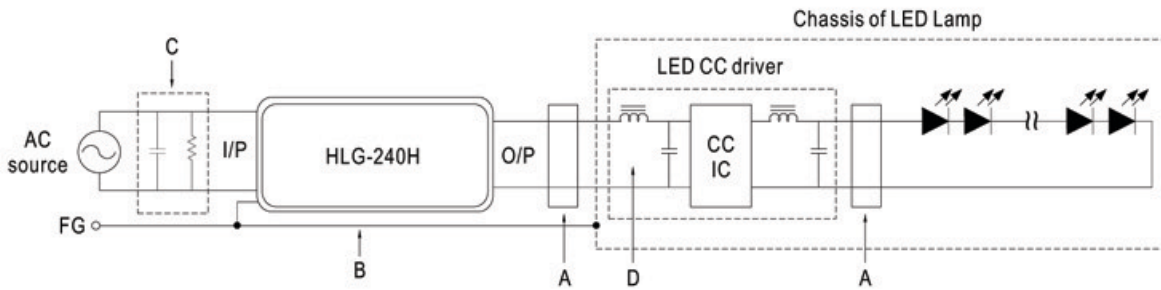

- A. Add a common mode ferrite choke on output wires to reduce the common emission between 10M ~ 300MHz per lighting EMI regulation.
- B. Chassis of LED lamp and chassis of HLG-240H or the FG wire should be connected to the safety ground to reduce the EMI noise, including the conduction and radiation emission.
- C. The additional X-Cap and discharge resistor can reduce the low frequency conduction noise between 9K ~ 1MHz per lighting EMI regulation.
- D. L-C filter should be added at the DC input of LED constant current driver to avoid the differential emission and high frequency noise generated by the CC driver.

WATERPROOF CONNECTION

☉ Waterproof connector

Waterproof connector can be assembled on the output cable of HLG-240H to operate in wet/damp or outdoor environment.

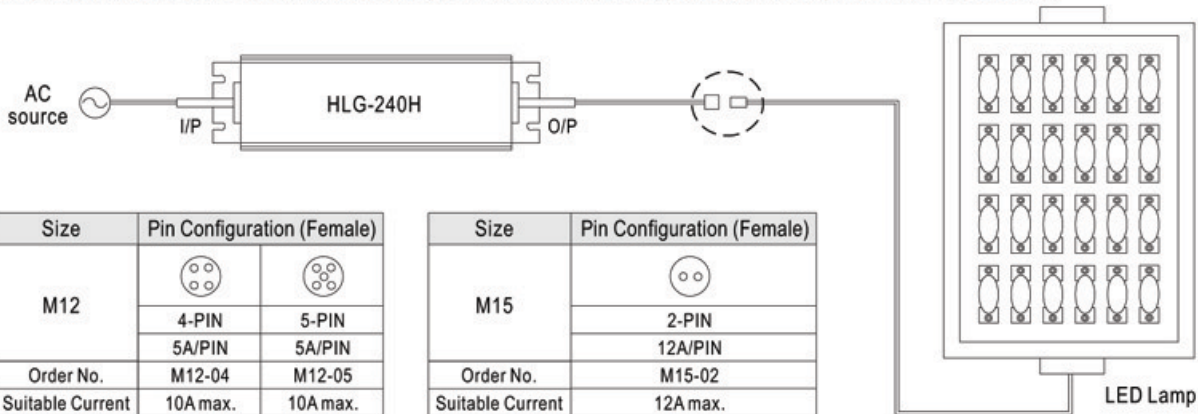

☉ Cable Joiner

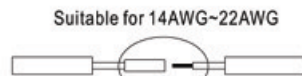
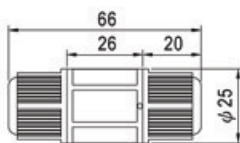

Up to four wires can be connected through this cable joiner by soldering or clamping by tools.

