



# CLEVELAND

## FAMILY OF PRODUCTS



OUTDOOR LIGHTING SPECIALISTS SINCE 1972

320 Clark Dr. | El Paso, TX 79951

Phone: (915) 779-1405

Toll Free: (800) 648-9013

Fax: (915) 779-3618

Toll Free: (888) 779-3065

email: [info@nilandco.com](mailto:info@nilandco.com)

[www.nilandco.com](http://www.nilandco.com)

## Cleveland Family

Niland Company poles are designed with maximum strength resistance to extreme wind loads but also functions with a wholesome selection of arms and luminaires. No matter the height, eight or twenty-eight feet, each pole is manufactured to the highest structural integrity.

### Features:

- ~ 5" deep fluted steel or aluminum shaft circumferentially welded around the inside of the base for **uncompromised structural integrity**.
- ~ Exterior transition ring to cast into the top of the base welded and ground smooth to mirror the design of shaft for **unitized construction**.
- ~ Optional **corporate branding** plate to customize any one of your projects.
- ~ **Heavy cast anchorage plate**. Four(4) L-shape anchor bolts to be used for anchoring. Optional direct burial.
- ~ **Historically accurate designs** with heavy cast iron or aluminum at a minimum wall thickness of .250".



roadway poles

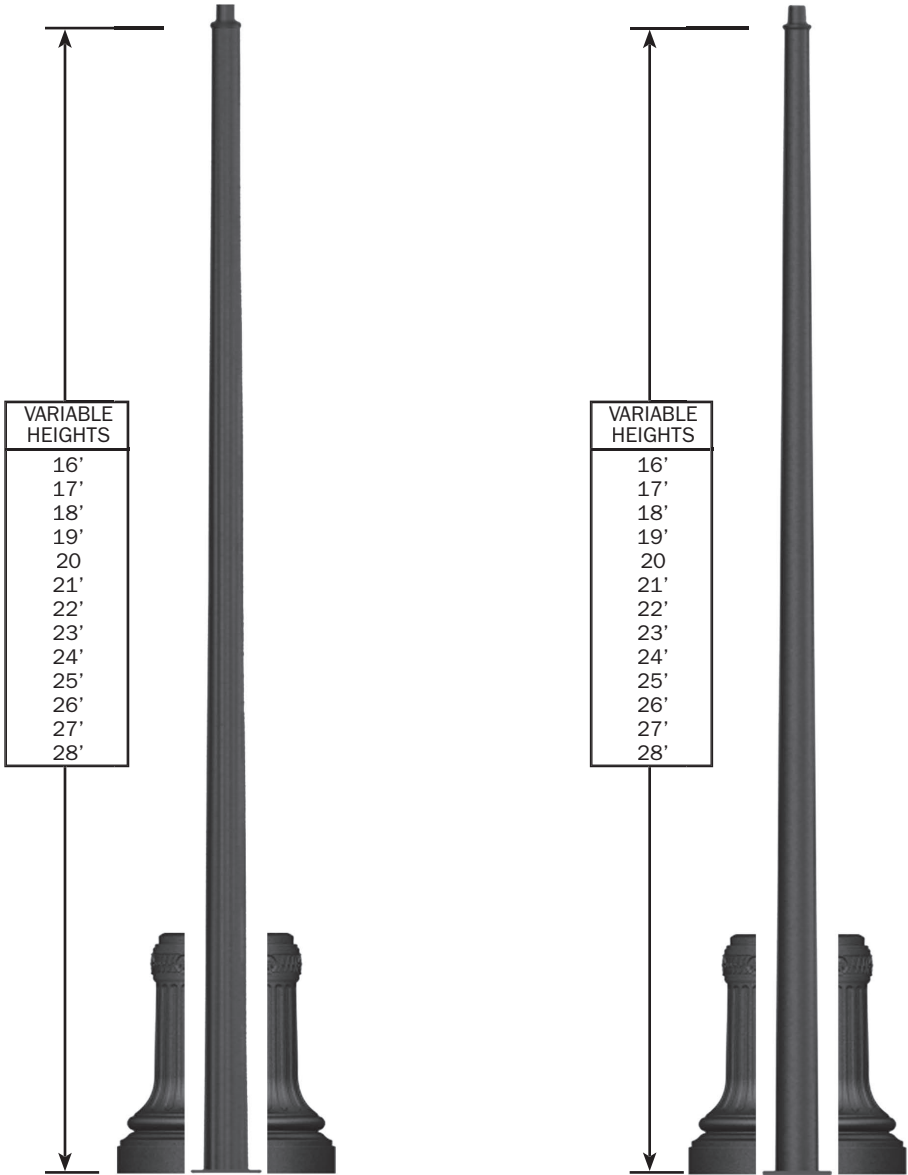

<b>MODEL#:</b>	CL-20	CL-20
<b>BASE HEIGHT:</b>	38 INCHES	38 INCHES
<b>BASE DIA:</b>	20 INCHES - CLAMSHELL	20 INCHES - CLAMSHELL
<b>SHAFT DIA:</b>	7.5 - 4.5 INCHES TAPERED FLUTED	7.5 - 4.5 INCHES TAPERED SMOOTH
<b>MATERIAL:</b>	STEEL/CAST IRON	STEEL/CAST IRON

**Pole Heights Variable Up to 28 Feet For Roadway Usage.**

**Shaft Options**

FLUTED      SMOOTH      TAPERED

All roadway shafts are tapered steel with 7.5 inch diameter from bottom to 4.5 inch diameter at top and clamshell base.

**uncompromised**

All bases are Cast Iron with minimum wall thickness of .1875 inch. Base casting has an internal sleeve of up to 25 inches deep. Shaft will be seated into the base sleeve and circumferentially welded around the inside of the base for uncompromised structural intergity. All exterior welds ground smooth.

## pedestrian poles

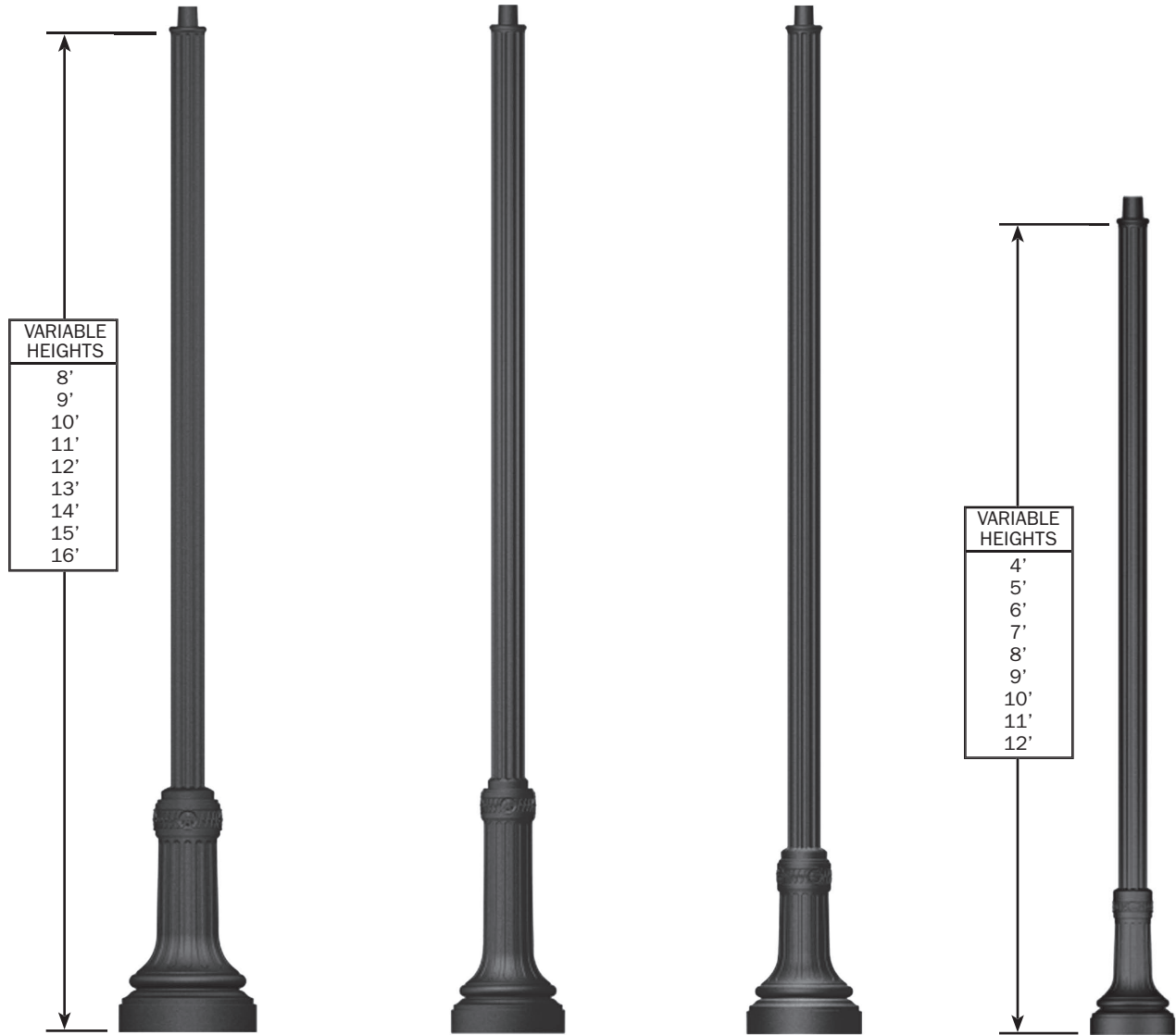

MODEL#:	CL-20	GCL-17	CL-17	CL-12
<b>BASE HEIGHT:</b>	38 INCHES	39 INCHES	27.75 INCHES	22 INCHES
<b>BASE DIA:</b>	20 INCHES	17 INCHES	17 INCHES	12 INCHES
<b>SHAFT DIA:</b>	5 INCHES	5 INCHES	5 INCHES	4 INCHES
<b>MATERIAL:</b>	CAST ALUMINUM	CAST ALUMINUM	CAST ALUMINUM	CAST ALUMINUM

### Pole Heights Variable Up to 16 Feet For Pedestrian Usage.

### Shaft Options

FLUTED      SMOOTH      TAPERED







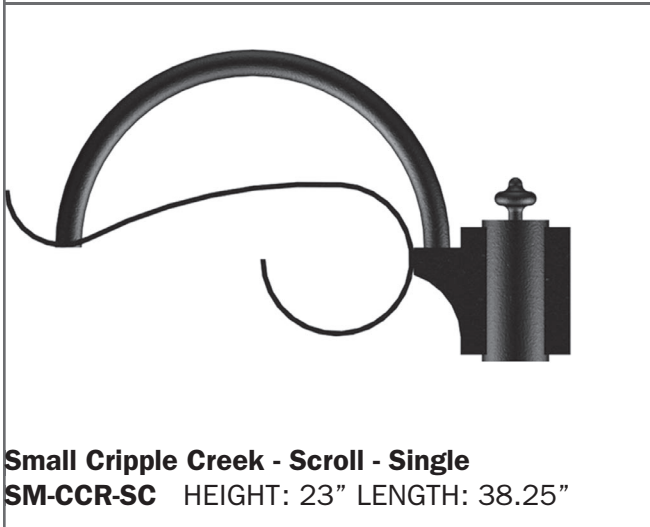

All pedestrian shafts are 4 inch or 5 inch diameters. Tapered shafts are 6 inch diameter from bottom to 3 inch diameter at top.

### uncompromised

All bases are Cast Aluminum with minimum wall thickness of .250 inch. Base casting has an internal sleeve of up to 25 inches deep. Shaft will be seated into the base sleeve and circumferentially welded around the inside of the base for uncompromised structural integrity. All exterior welds ground smooth.

roadway arms



- configurations:**
-  PM
  -  1
  -  2
  -  2L
  -  3C
  -  3
  -  4
  -  4C
  -  WM

## pedestrian arms

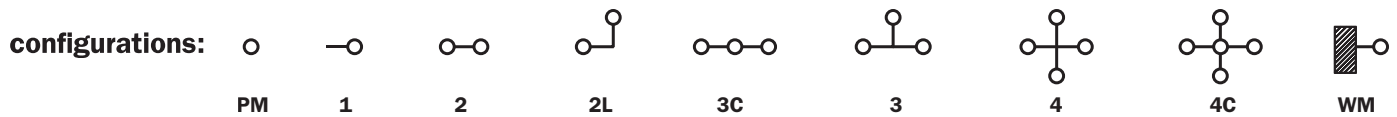
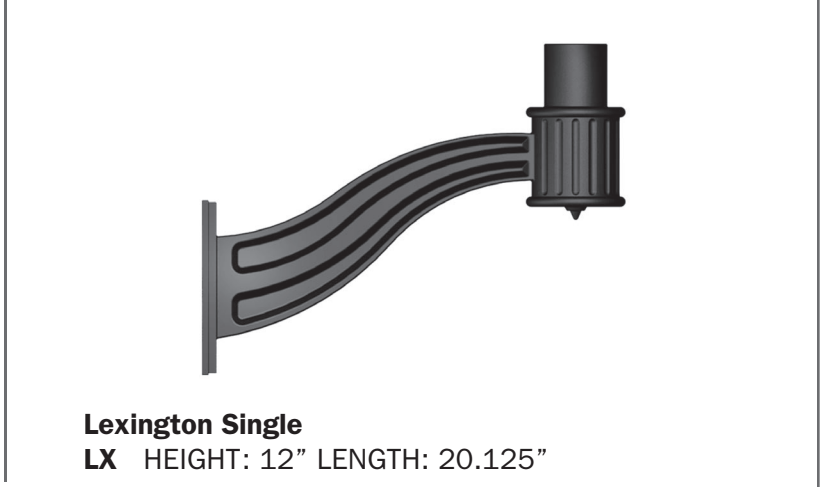
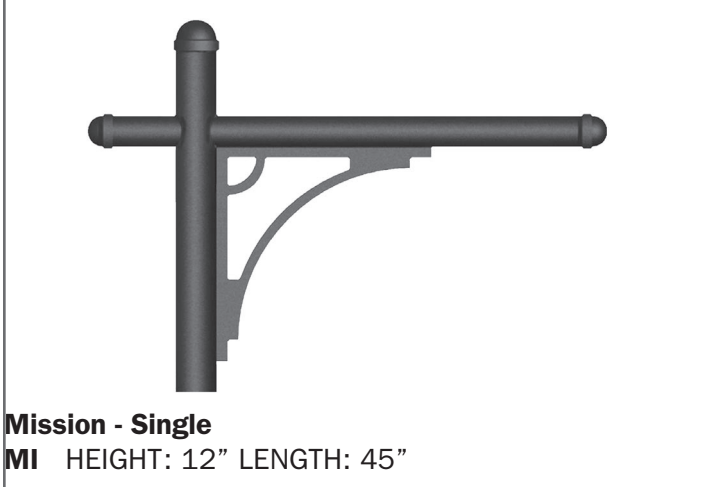
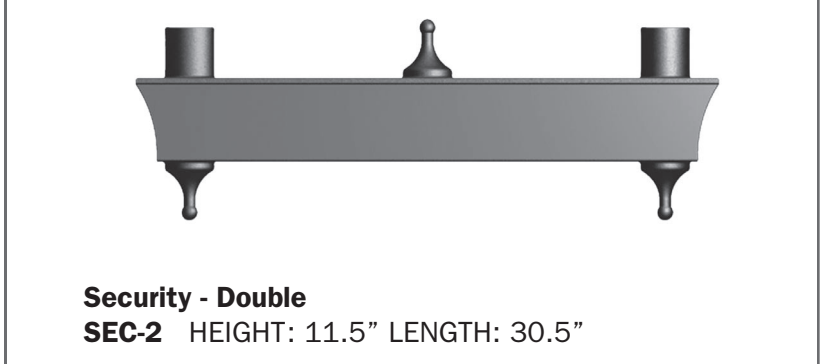

roadway luminaires



<b>MODEL#:</b>	SZ-FLAT	BC-17-FLAT	BC-20-FLAT	RS-BC-26-FLAT	BA-PEN-HYD-HOR
<b>WIDEST DIA:</b>	20 INCHES	17 INCHES	20 INCHES	25.875 INCHES	19.125 INCHES
<b>HEIGHT:</b>	16.25 INCHES	19.375 INCHES	22 INCHES	19.75 INCHES	37.5 INCHES

pedestrian luminaires



<b>MODEL#:</b>	BA-CON-HYD-HOR	MS-LEX-424-CON-E	CR-LEX-424-CON-S	JT-HYD-HOR	AP-HYD-HOR
<b>WIDEST DIA:</b>	19.125 INCHES	19 INCHES	19 INCHES	23 INCHES	24 INCHES
<b>HEIGHT:</b>	33.5 INCHES	42.125 INCHES	40 INCHES	41.25 INCHES	36 INCHES



**Lamp Access**  
 Quick disconnect terminals between the lamp and ballast allow for safe removal of the lamp. Tool-free quarter-turn of the Twist 'N' Seal base makes for easy relamping with a sealed optics chamber.



**Remote Ballast**  
 Ballast is easily accessed by removing the bird plate and the unitized ballast tray. Quick disconnect terminals are again used to ensure safe ballast maintenance.

## ballast/lamp

Model	Description
70HPS	70 watt high pressure sodium; use a medium base, clear ED-17 lamp.
100HPS	100 watt high pressure sodium; use a medium base, clear ED-17 lamp.
150HPS	150 watt high pressure sodium; use a medium base, clear ED-17 lamp.
50MH	50 watt metal halide; use a medium base, clear ED-17 lamp.
70MH	70 watt metal halide; use medium base, clear ED-17 lamp.
70MHT6	70 watt metal halide; use a G12 base, T-6 ceramic MH lamp.
100MH	100 watt metal halide; use medium base, clear ED-17 lamp.
150MH	150 watt metal halide; use medium base, clear ED-17 lamp.
150MHT6	150 watt metal halide; use G12 base, T-6 ceramic MH lamp.
175MH	175 watt metal halide; use medium base, clear ED-17 lamp.
CF	Compact Fluorescent, electronic ballast; Use 4-pin 26,32 or 42 watt lamp.

## voltage

120 / 208 / 240  
/ 277 / 347\* / 480\*

\*Not available for QL lamp.

Multitap ballast also available.

\*\*Please specify wattage and voltage upon ordering.

Lamps (bulbs) not included in packages.

## QL Induction Lamp 50,000 HOURS AVERAGE LIFE

**55, 85 and 165 Watt Systems**  
**Offering Electrodeless Technology with**  
**a 50,000 Hours Rated Average Life!**

### Features:

- Ultra Long Life
- Crisp White Light
- No Color Shift
- High Reliability
- Operates in Hot & Cold Environments
- Low EMI
- High Lumen Output



With QL Induction Lighting,  
**the grass IS greener!**

## High Power LED Units OVER 100,000 HOURS AVERAGE LIFE

**Retrofits for Existing Fixtures**  
**or As A Complete Unit**

### Features:

- Increased Visual Acuity
- Minimal Energy Consumption
- Dark Sky Friendly
- Decreased Maintenance
- Instant "On"
- Wireless Access and Dimming Capabilities
- 40ft Maximum Mounting Height
- Lighting Detection System

Without the use of harmful mercury  
that traditional HID lamps use,

the grass is not only greener, **it's growing!**



## light distribution options



### Horizontal Hydro-Formed Reflector (HYD-HOR)

Type III hydro-formed reflector shield. Full cut-off optics with Twist 'N' Seal mogul base. Dark Sky compliant with fully sealed reflector housing.

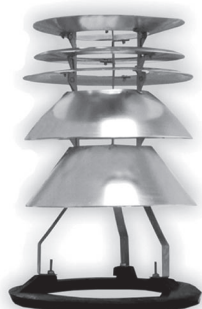

### Louver Reflector (LOUVER)

Spun aluminum with mirror finish. Assists in reflecting light downward.



### Borosilicate Refractor (BOR)

Glass with high resistance to intense amounts of heat for long periods of time. Type III or V light distribution.



**photometric data - BA-CON-HYD-HOR 150HPS**

The values below are initial footcandles. Decrease values to justify light losses due to voltage, temperature and atmospheric variations which may affect light output. All testing performed by a certified independent laboratory. Photometry is available in IES formatted files on CD-ROM and website at [www.nilandco.com](http://www.nilandco.com) or call your local representative.



**FLUX DISTRIBUTION**

	Lumens	Percent Of Lamp
Downward Street Side	5729.6	35.8
Downward House Side	4806.0	30.0
Downward Total	10535.6	65.8
Upward Street Side	7.7	0.0
Upward House Side	10.5	0.1
Upward Total	18.2	0.1
<b>Total Flux</b>	<b>10553.8</b>	<b>66.0</b>

**COEFFICIENTS OF UTILIZATION**

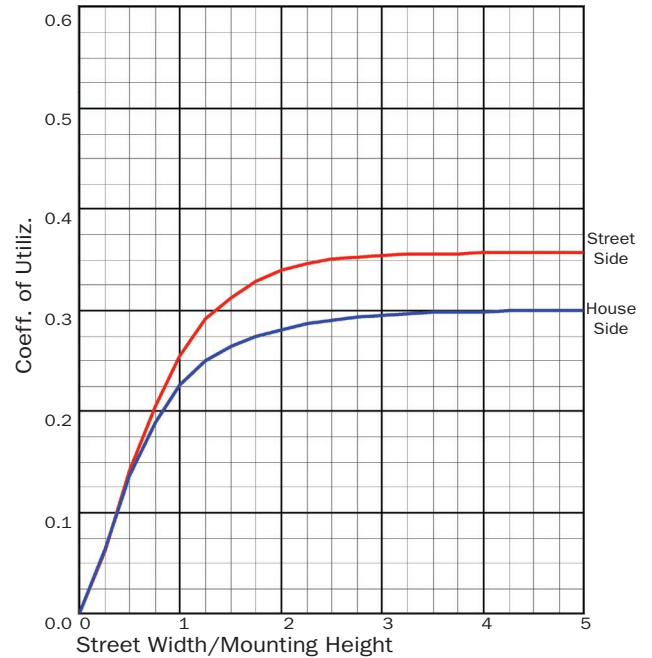

**POLAR GRAPH**

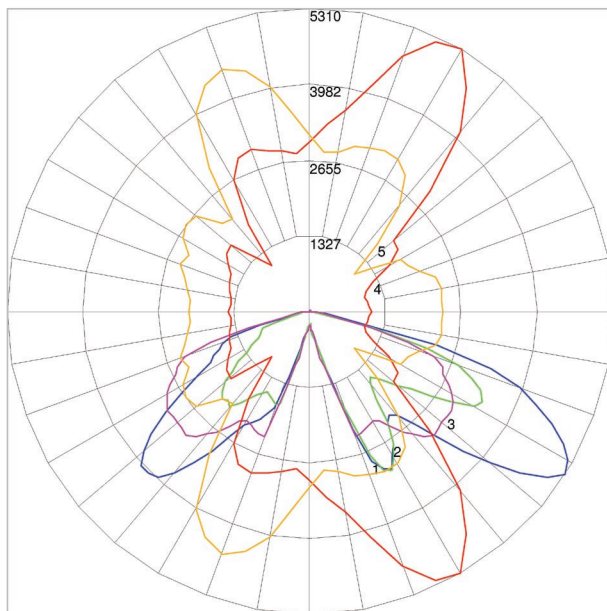

Maximum Candela = 5309.91  
 Located at Horizontal Angle = 60, Vertical Angle = 57.5  
 #1 - Vertical Plane Through Horizontal Angles (60-240)  
 (Through Max. Cd.)  
 #2 - Vertical Plane Through Horizontal Angles (45-225)  
 #3 - Vertical Plane Through Horizontal Angles (90-270)  
 #4 - Horizontal Cone Through Vertical Angle (57.5)  
 (Through Max. Cd.)  
 #5 - Horizontal Cone Through Vertical Angle (45)

**ISO FOOTCANDLE LINES OF HORIZONTAL ILLUMINANCE**

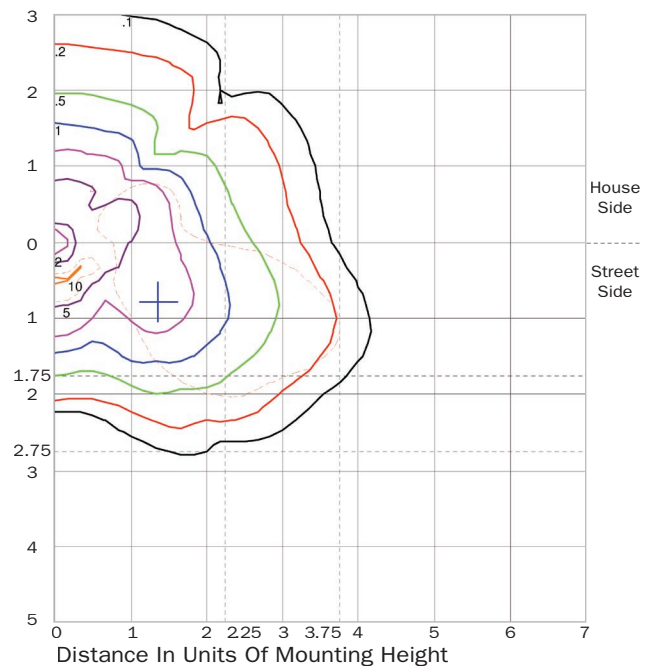

Values Based On 15 Foot Mounting Height

1/2 Maximum Candela Trace Shown  
 As Dashed Curve

(+) = Maximum Candela Point

Photometric data containing additional wattages and luminaires are available online at <http://www.nilandco.com>.

## finish options



Textured  
Forest Green (TG)



Textured  
Playground Green (TP)



Textured  
El Paso Green (TE)



Gloss  
Green (GG)



Gloss  
Black Green (BG)

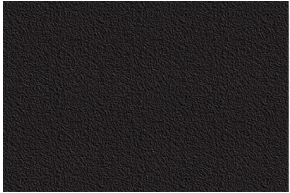

Textured  
Black (TB)



Mineral  
Bronze (MR)



Hand Brushed  
Verdi Gris (VG)



Gloss  
Black (GB)



Gloss  
Walnut (GW)

All finishes above are standard and offered at no extra charge.  
Custom colors: please provide RAL number or sample chip.

## accessories

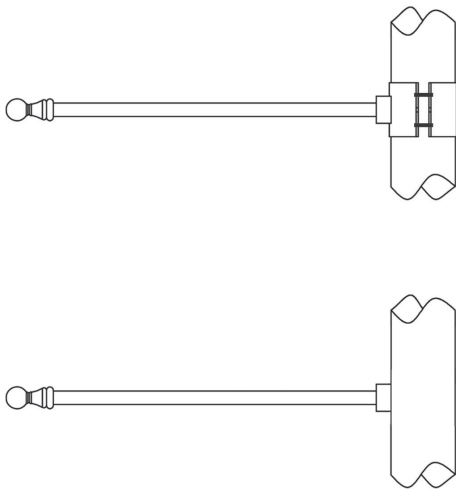

### Banner Arms (BAN)

All banner arms fabricated with 24-inch rounded aluminum shaft at 1-inch diameter. Clamped around diameter of 4 or 5 inch pole. Double banner arms also available.

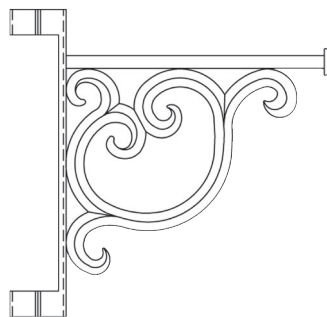

### Planter Arms (PA)

All planter arms fabricated with aluminum at 28 inch height and 24 inch length. Clamped around diameter of 4 inch or 5 inch pole. Double planter arms also available.

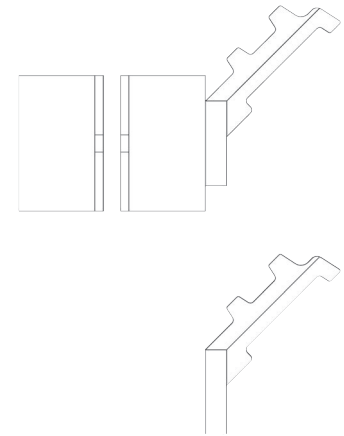

### Flag Pole Holder (FLAG)

Holder are available as clamp or bolt mount for 4 inch or 5 inch poles. Overall height is 4 inches and reach is 3 inches.

**sign backers**

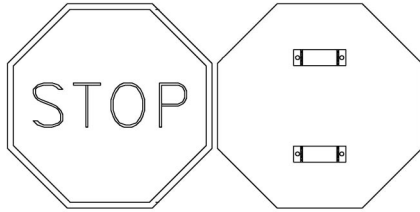

POLE MOUNT: FRONT BACK

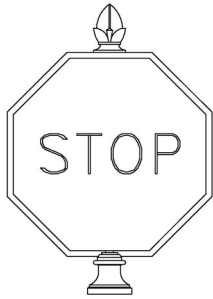

TOP MOUNT: FRONT

**Stop Sign Backer (STOP)**

Stop Signs available in 24 inch or 30 inch diameter. Fabricated in 356 cast aluminum with a thickness of .1875 inch and .375 inch offset lip. Can be clamped around 4 inch or 5 inch diameter pole. Bolt and top mount also available. Please specify mounting height upon ordering.

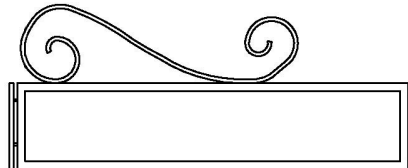

PAD-24-SQ-SC

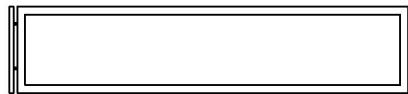

PAD-24-SQ

**24 Inch Square Paddle Sign Backer (PAD-24-SQ)**

Square Street Sign Paddles available in 24 inch length by 4.5 inch height. Fabricated in 356 cast aluminum with a thickness of .1875 inch and .375 inch offset lip. Can be clamped around 4 inch or 5 inch diameter pole. Bolt mount also available. Please specify mounting height upon ordering. Optional decorative scroll available.

All signage does NOT include dacals.  
Please specify heighth and width when ordering custom sizes.

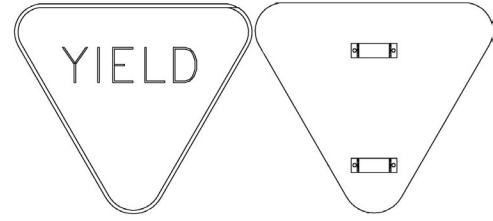

POLE MOUNT: FRONT BACK

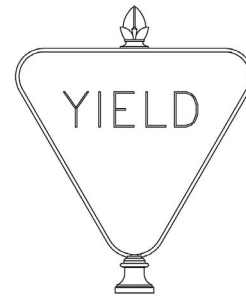

TOP MOUNT: FRONT

**Yield Sign Backer (YIELD)**

Yield Signs available in 28 inch or 30 inch height. Fabricated in 356 cast aluminum with a thickness of .1875 inch and .375 inch offset lip. Can be clamped around 4 inch or 5 inch diameter pole. Bolt and top mount also available. Please specify mounting height upon ordering.

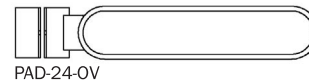

PAD-24-OV

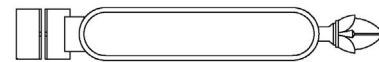

PAD-24-OV-FINIAL

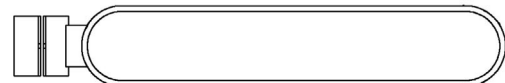

PAD-36-OV

**24 Inch Oval Paddle Sign Backer (PAD-24-OV or PAD-36-OV)**

Oval Street Sign Paddles available in 24 inch length by 4.5 inch height or 36 inch length by 6 inch height. Fabricated in 356 cast aluminum with a thickness of .1875 inch and .375 inch offset lip. Can be clamped around 4 inch or 5 inch diameter pole. Bolt mount also available. Please specify mounting height upon ordering. Optional decorative finial available.

# Cleveland Family

## scaled view: roadway

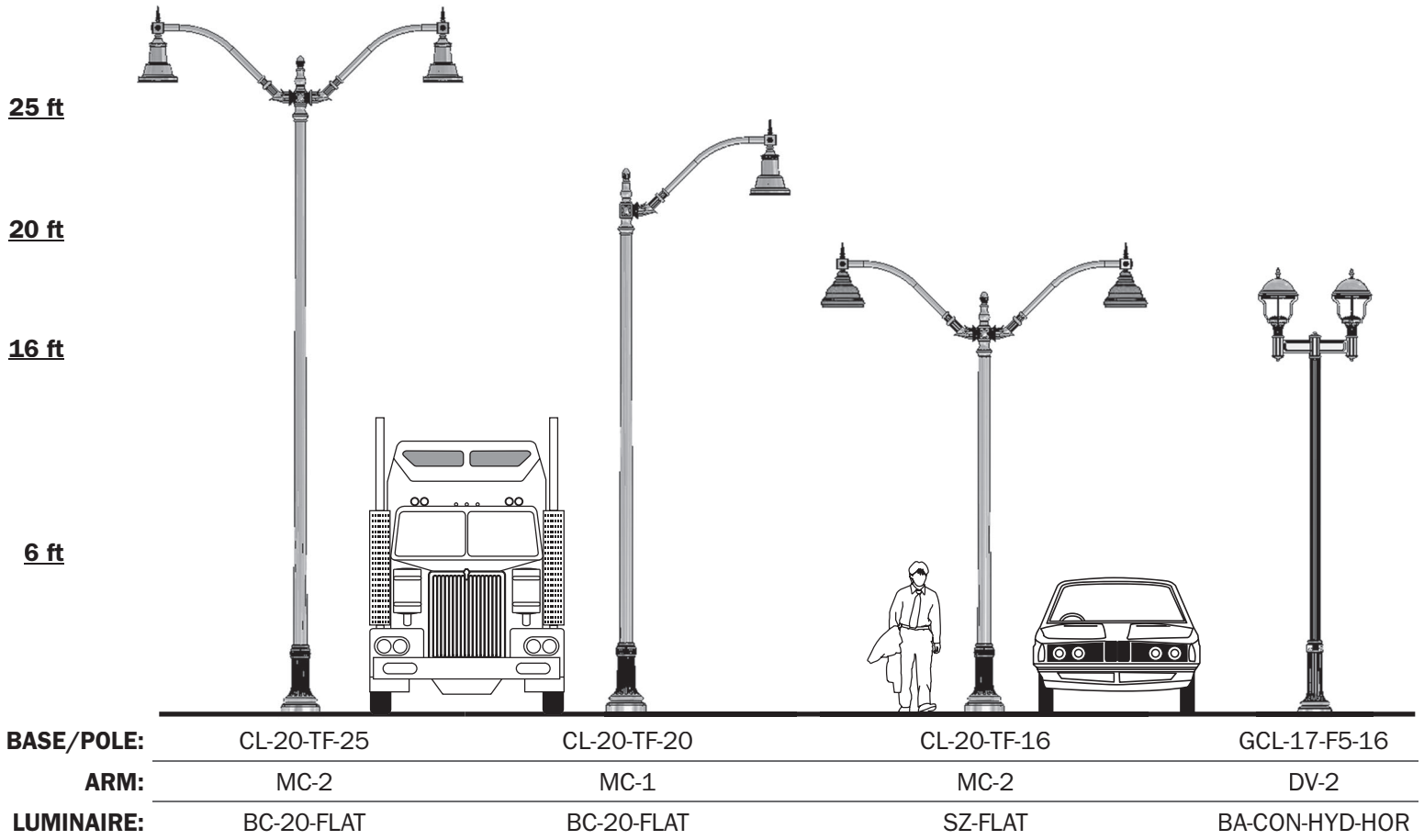

## scaled view: pedestrian

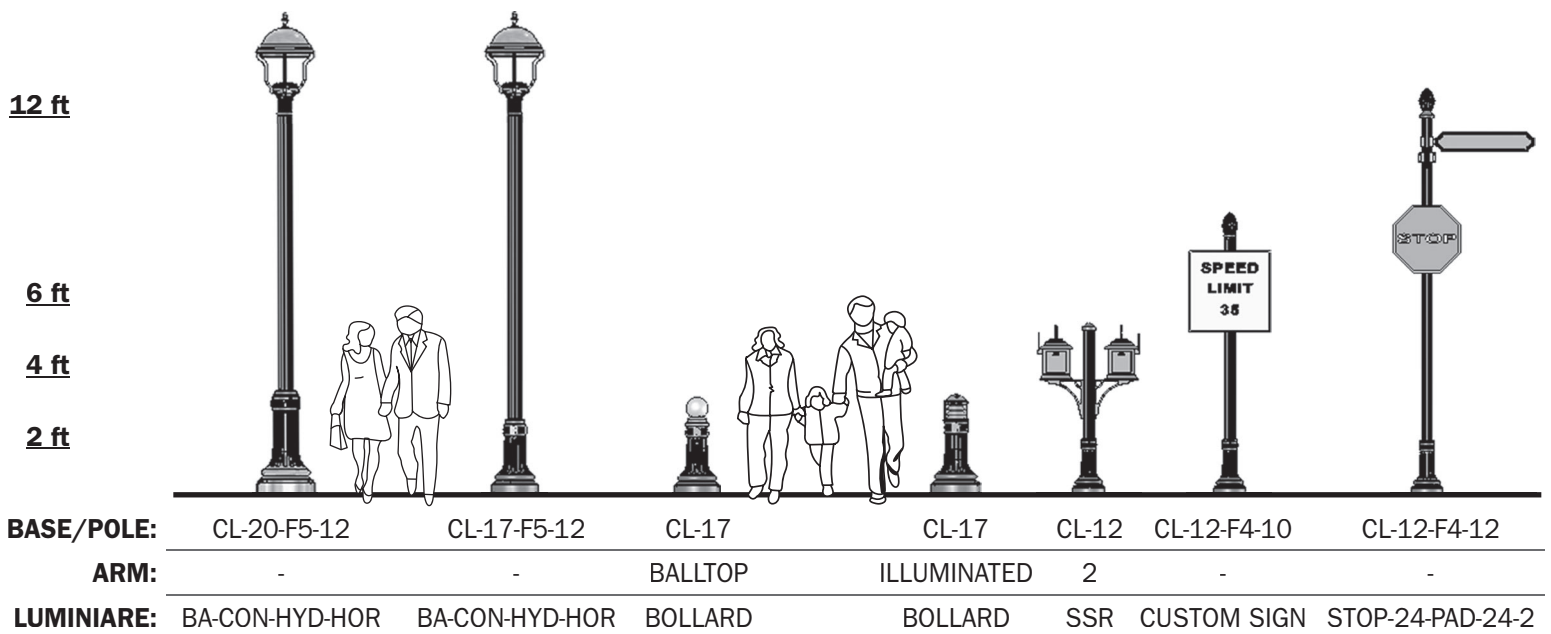

**ordering guide**

Example: CL-17 - F5 - 14 - DV - 2 - BA-CON - HYD-HOR - MH - 240 - 100 - TB - BAN-1  
 (A) (B) (C) (D) (E) (F) (G) (H) (I) (J) (K) (L)

**(A)BASE TYPE:**

CL-12 = Cleveland Series  
with 12" base dia.  
 CL-17 = Cleveland Series  
with 17" base dia.  
 GCL-17 = Grand Cleveland Series  
with 17" base dia.  
 CL-20 = Cleveland Series  
with 20" base dia.

**(B)POLE/SHAFT TYPE:**

F4 = Fluted 4" dia.  
 F5 = Fluted 5" dia.  
 TFS = Tapered Fluted Steel\*  
 S4 = Smooth 4" dia.  
 S5 = Smooth 5" dia.  
 TSS = Tapered Smooth Steel\*

\*Roadway Only.

**(C)HEIGHT:**

Pedestrian  
 8 = 8Ft  
 9 = 9Ft  
 10 = 10Ft  
 11 = 11Ft  
 12 = 12Ft  
 UP TO 16Ft  
 Roadway  
 16 = 16Ft  
 17 = 17Ft  
 18 = 18Ft  
 19 = 19Ft  
 20 = 20Ft  
 UP TO 28Ft

**(D)ARM TYPE:**

MC = Manchester  
 SM-CCR-SC = Small Cripple Creek with Scroll  
 MI = Mission  
 LX = Lexington  
 SEC = Denver  
 CCR = Cripple Creek  
 CCR-SC = Cripple Creek with Scroll

**(E)NUMBER OF ARMS:**

UP TO 4 ARMS

**(F)FIXTURE TYPE:**

(following luminaires come stock with type III hydro-formed reflector)

SZ-FLAT = Santa Cruz Flat  
 BC-20-FLAT = Boston Common 20" Flat  
 RS-BC-26-FLAT = Residency 26" Flat  
 BA-PEN-HYD-HOR = Barcelona Pendent Mount  
 BA-CON-HYD-HOR = Barcelona Standard Finial  
 JT-HYD-HOR = Jamestown Full Cut Off  
 AP-HYD-HOR = Aspen Full Cut Off

(following luminaires come stock with refractive lexilite lens)

MS-LEX-424-CON-E = Mesilla 424 Lexilite Lens  
 CR-LEX-424-CON-S = Carolina 424 Lexilite Lens

**(G)REFLECTOR/REFRACTOR TYPE:**

HYD-HOR = Hydroformed Horizontal Reflector  
 LOUVER = Louvers Reflector  
 BOR = Borosilicate Glass Refractor

**(H)LAMP TYPE:**

MH = Metal Halide  
 HPS = High Pressure Sodium  
 CF = Compact Fluorescent  
 QL = QL Induction Lamp

**(I)VOLTAGE:**

120 = 120 Volts  
 208 = 200 Volts  
 240 = 240 Volts  
 277 = 277 Volts  
 347\* = 347 Volts\*  
 480\* = 480 Volts\*  
 MT = Multitap (120,208,240,277)

\*Not available for QL lamp.

**(J)WATTAGE:**

Pease reference ballast chart.

**(K)FINISH:**

TB = Textured Black  
 TE = Textured El Paso Green  
 TG = Textured Forest Green  
 TP = Textured Playground Green  
 MR = Mineral Bronze  
 GB = Gloss Black  
 GG = Gloss Green  
 BG = Black Green  
 GW = Gloss Walnut  
 VG = Handbrushed Verdi Gris  
 CUSTOM = Specify RAL #  
or Provide Sample

**(L)ACCESSORES:**

BAN-1 = Single Banner Arm  
 BAN-2 = Double Banner Arm  
 PA-1 = Single Planter Arm  
 PA-2 = Double Planter Arm  
 FLAG = Flag Pole Holder  
 STOP-TM = Top Mount Stop Sign Backer  
 STOP-PM = Pole Mount Stop Sign Backer  
 YIELD-TM = Top Mount Yield Sign Backer  
 YIELD-PM = Pole Mount Yield Sign Backer  
 PAD-24-SQ = 24" Square Paddle Sign Backer  
 PAD-24-SQ-SC = 24" Square Paddle Sign  
Backer with Scroll  
 PAD-24-OV = 24" Oval Paddle Sign Backer  
 PAD-24-OV-FINIAL = 24" Oval Paddle Sign  
Backer with Standard Finial  
 PAD-36-OV = 36" Oval Paddle Sign Backer



# CLEVELAND

## FAMILY OF PRODUCTS

### BC-17-FLAT: 175MH

#### CHARACTERISTICS

IES Classification	Type III
Longitudinal Classification	Short
Cutoff Classification	Full Cutoff
Total Rated Lamp Lumens	14000
Maximum Candela	6329.3
Maximum Candela Angle	60H 57.5V
Maximum Candela at 90 Degrees Vertical	0 (0.00% Lamp Lms)
Maximum Candela at 80 Degrees Vertical	776.59 (5.55% Lamp Lms)
Downward total Efficiency	78.9%



#### COEFFICIENTS OF UTILIZATION

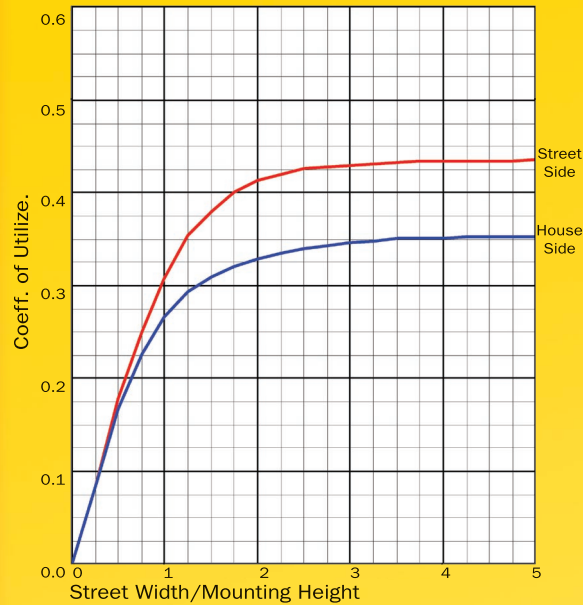

#### ISO FOOTCANDLE LINE OF HORIZONTAL ILLUMINANCE

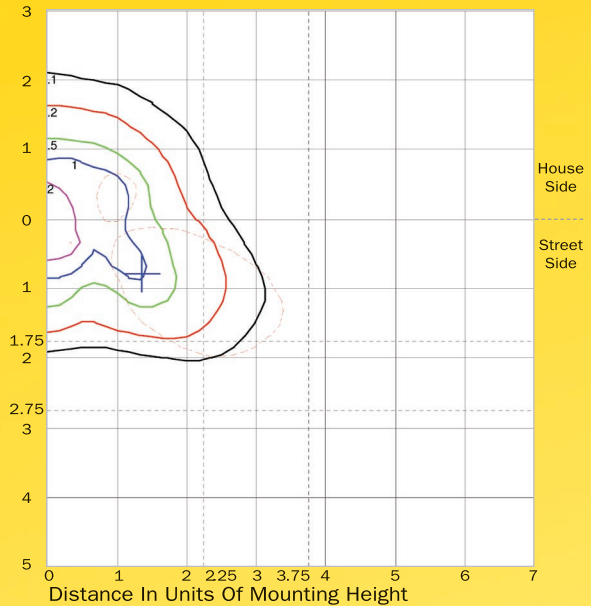

#### FLUX DISTRIBUTION

	Lumens	Percent Of Lamp
Downward Street Side	6102.8	43.6
Downward House Side	4945.6	35.3
Downward Total	11048.4	78.9
Upward Street Side	0.0	0.0
Upward House Side	0.0	0.0
Upward Total	0.0	0.0
<b>Total Flux</b>	<b>11048.4</b>	<b>78.9</b>

Values Based On 30 Foot Mounting Height

1/2 Maximum Candela Trace Shown  
As Dashed Curve

(+) = Maximum Candela Point



320 Clark Dr. | El Paso, TX 79951

Phone: (915) 779-1405  
Toll Free: (800) 648-9013

Fax: (915) 779-3618  
Toll Free: (888) 779-3065

email: [info@nilandco.com](mailto:info@nilandco.com)

[www.nilandco.com](http://www.nilandco.com)